

# Cilindros de rueda

Wheel cylinders

Cilindros de roda

## CHEVROLET - GM

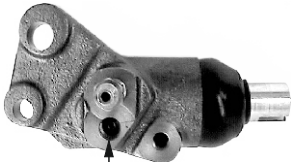
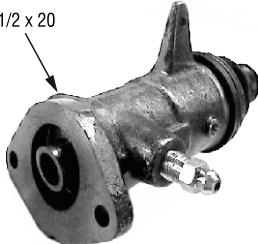
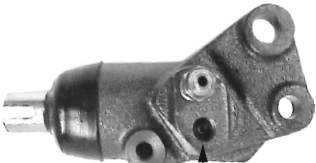

	Código/Code	Original Nº	Modelos / Models	Posición / Position	Ø
 <p>7/16 x 20 NF con cono / with cone</p>	<b>K-2052</b>	2400663 5747743	Bedford 63/66 C60 67/69	Delantero - Izquierdo Front - Left Dianteiro - Esquerdo	1" 1/4
 <p>7/16 x 20 NF con cono / with cone</p>	<b>K-2053</b>	2400664 5747744	Bedford 63/66 C60 67/69	Delantero - Derecho Front - Right Dianteiro - Direito	1" 1/4
 <p>1/2 x 20</p>	<b>K-5060</b>	6317780/A	Bedford 57/66	Trasero Rear Traseiro	1" 9/16
 <p>7/16 x 20 NF</p>	<b>K-5152</b>	2401514	C60 - CD600 69/78	Delantero - Izquierdo Front - Left Dianteiro - Esquerdo	1" 1/8

**Cilindros de rueda**  
Wheel cylinders  
Cilindros de roda

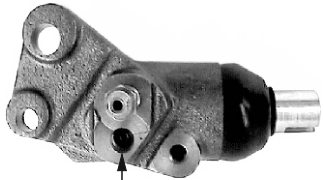
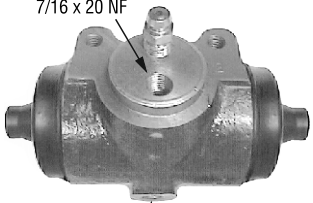
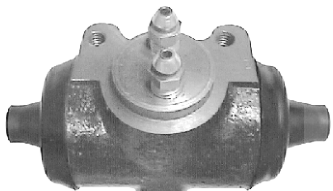
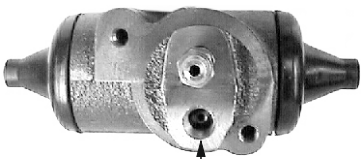

**CHEVROLET - GM**

	Código/Code	Original Nº	Modelos / Models	Posición / Position	Ø
 <p>7/16 x 20 NF</p>	<b>K-5153</b>	2401515	C60 - CD600 69/78	Delantero - Derecho Front - Right Dianteiro - Direito	1" 1/8
 <p>7/16 x 20 NF</p> <p>3/8 x 24 NF</p>	<b>K-2054</b>	28850	C50	Trasero - Inferior Rear - Lower Traseiro - Inferior	1" 1/2
 <p>3/8 x 24 NF</p>	<b>K-2055</b>	28851	C50	Trasero - Superior Rear - Upper Traseiro - Superior	1" 1/2
 <p>7/16 x 24 NS con cono / with cone</p>	<b>K-2060</b>	2401417 3772241	C60 D60 CD600 67/78	Trasero Rear Traseiro	1" 5/8

# Cilindros de rueda

Wheel cylinders  
Cilindros de roda



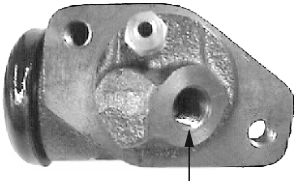
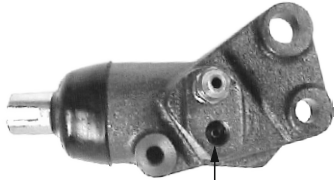
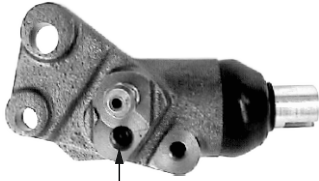
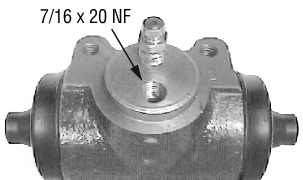
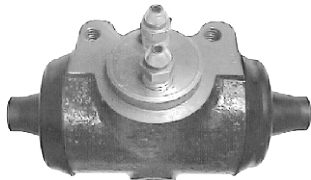

## DODGE

	Código/Code	Original N°	Modelos / Models	Posición / Position	Ø
 <p>7/16 x 20 NF</p>	<b>K-4050</b>	2400276 9697	D400 D500 64/73	Delantero - Izquierdo Front - Left Dianteiro - Esquerdo	1"
 <p>7/16 x 20 NF</p>	<b>K-4051</b>	2400277 9698	D400 D500 64/73	Delantero - Derecho Front - Right Dianteiro - Direito	1"
 <p>7/16 x 20 NF con cono / with cone</p>	<b>K-2052</b>	2400663 5747743	D600 DP600 66/78	Delantero - Izquierdo Front - Left Dianteiro - Esquerdo	1" 1/4
 <p>7/16 x 20 NF con cono / with cone</p>	<b>K-2053</b>	2400664 5747744	D600 DP600 66/78	Delantero - Derecho Front - Right Dianteiro - Direito	1" 1/4
 <p>7/16 x 20 NF 3/8 x 24 NF</p>	<b>K-2054</b>	28850	D400 D500 59/63	Trasero - Inferior Rear - Lower Traseiro - Inferior	1" 1/2
 <p>3/8 x 24 NF</p>	<b>K-2055</b>	28851	D400 D500 59/63	Trasero - Superior Rear - Upper Traseiro - Superior	1" 1/2

**Cilindros de rueda**  
Wheel cylinders  
Cilindros de roda

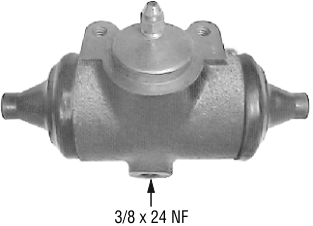
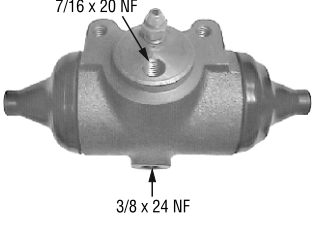
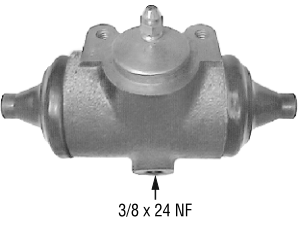
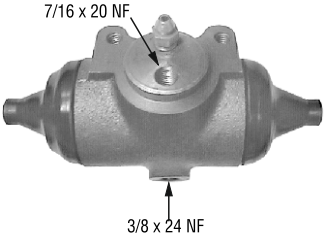

**DODGE**

	Código/Code	Original N°	Modelos / Models	Posición / Position	Ø
 <p>3/8 x 24 NF</p>	<b>K-4060</b>	2400019	D400 D500 64/71	Trasero - Superior - Izquierdo Rear - Upper - Left Traseiro - Superior - Esquerdo	1" 5/8
 <p>7/16 x 20 NF 3/8 x 24 NF</p>	<b>K-4062</b>	2400021	D400 D500 64/71	Trasero - Inferior - Izquierdo Rear - Lower - Left Traseiro - Inferior - Esquerdo	1" 5/8
 <p>3/8 x 24 NF</p>	<b>K-4061</b>	2400020	D400 D500	Trasero - Superior - Derecho Rear - Upper - Right Traseiro - Superior - Direito	1" 5/8
 <p>7/16 x 20 NF 3/8 x 24 NF</p>	<b>K-4063</b>	2400022	D400 D500	Trasero - Inferior - Derecho Rear - Lower - Right Traseiro - Inferior - Direito	1" 5/8
 <p>7/16 x 24 NS con cono / with cone</p>	<b>K-2060</b>	2401417 3772241	D600 DP600 67/78	Trasero Rear Traseiro	1" 5/8

# Cilindros de rueda

Wheel cylinders  
Cilindros de roda

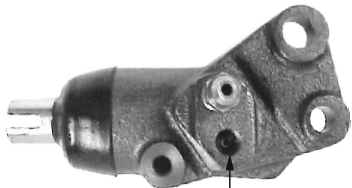
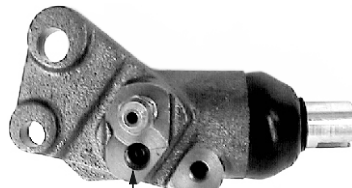
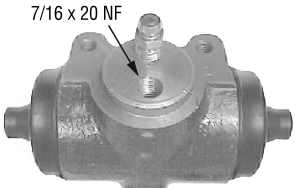
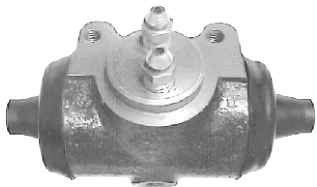
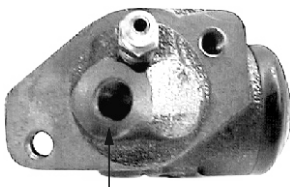
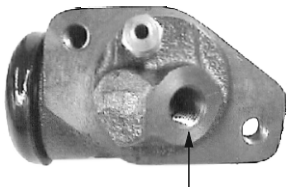

## FORD

	Código/Code	Original Nº	Modelos / Models	Posición / Position	Ø
 <p>7/16 x 20 NF con cono / with cone</p>	<b>K-2052</b>	2400663 5747743	F 700 68 -> B 600	Delantero - Izquierdo Front - Left Dianteiro - Esquerdo	1" 1/4
 <p>7/16 x 20 NF con cono / with cone</p>	<b>K-2053</b>	24000664 5747744	F 700 68 -> B 600	Delantero - Derecho Front - Right Dianteiro - Direito	1" 1/4
 <p>7/16 x 20 NF 3/8 x 24 NF</p>	<b>K-2054</b>	28850	F 500 59/61	Trasero - Inferior Rear - Lower Traseiro - Inferior	1" 1/2
 <p>3/8 x 24 NF</p>	<b>K-2055</b>	28851	F 500 59/61	Trasero - Superior Rear - Upper Traseiro - Superior	1" 1/2
 <p>7/16 x 20 NF</p>	<b>K-4050</b>	2400276 9697	F 600 F 6000 64/80	Delantero - Izquierdo Front - Left Dianteiro - Esquerdo	1"
 <p>7/16 x 20 NF</p>	<b>K-4051</b>	2400277 9698	F 600 F 6000 64/80	Delantero - Derecho Front - Right Dianteiro - Direito	1"

# Cilindros de rueda

Wheel cylinders  
Cilindros de roda



## FORD

	Código/Code	Original N°	Modelos / Models	Posición / Position	Ø
<p>7/16 x 24 NS con cono / with cone</p>	<b>K-4056</b>	28661	F 500 61/64	Trasero - Superior - Inferior Rear - Upper - Lower Traseiro - Superior - Inferior	1" 1/2
<p>7/16 x 24 NS con cono / with cone</p>	<b>K-2060</b>	2401417 3772241	F 500 F 600 F 700 68/78	Trasero Rear Traseiro	1" 5/8
<p>3/8 x 24 NF</p>	<b>K-4060</b>	2400019	F 500 F 600 F 6000 64/80	Trasero - Superior - Izquierdo Rear - Upper - Left Traseiro - Superior - Esquerdo	1" 5/8
<p>7/16 x 20 NF 3/8 x 24 NF</p>	<b>K-4062</b>	2400021	F 500 F 600 F 6000 64/80	Trasero - Inferior - Izquierdo Rear - Lower - Left Traseiro - Inferior - Esquerdo	1" 5/8
<p>3/8 x 24 NF</p>	<b>K-4061</b>	2400020	F 500 F 600 F 6000 64/80	Trasero - Superior - Derecho Rear - Upper - Right Traseiro - Superior - Direito	1" 5/8
<p>7/16 x 20 NF 3/8 x 24 NF</p>	<b>K-4063</b>	2400022	F 500 F 600 F 6000 64/80	Trasero - Inferior - Derecho Rear - Lower - Right Traseiro - Inferior - Direito	1" 5/8



# Cilindros de rueda

Wheel cylinders

Cilindros de roda

**MAQ. AGRICOLAS / VIALES / AUTOELEVADORES**

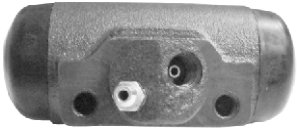
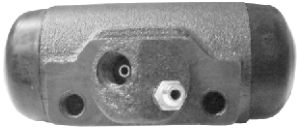

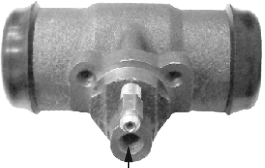
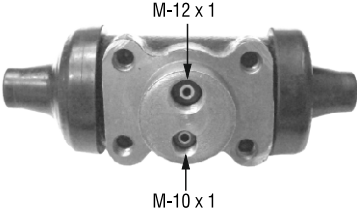
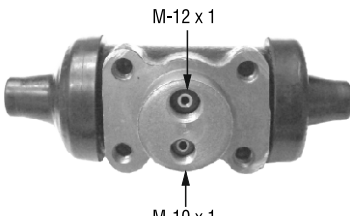
	Código/Code	Original Nº	Modelos / Models	Posición / Position	Ø
	K-9565		Autoelevadores chinos		1" 1/8
	K-9561		Autoelevadores Toyota	Trasero - Izquierdo Rear - Left Traseiro - Esquerdo	1" 1/8
	K-9562		Autoelevadores Toyota	Trasero - Derecho Rear - Right Traseiro - Direito	1" 1/8
	K-9860	BB171	Barredoras Dixit		15/16
	K-9861		Barredoras Dixit		3/4
 7/16 x 20	K-1350		Palas Caterpillar Komatsu		1" 3/4
 M-12 x 1 M-10 x 1	K-1351	92046-04200	Palas Caterpillar Komatsu Mitsubishi		1" 3/8
 M-12 x 1 M-10 x 1	K-1352		Palas Caterpillar Komatsu Mitsubishi		1" 1/4

# Cilindros de rueda

Wheel cylinders

Cilindros de roda

## MERCEDES BENZ

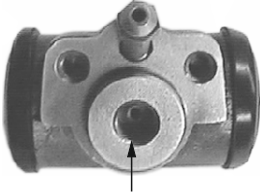
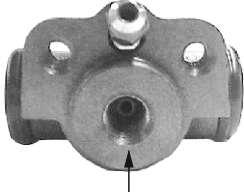

	Código/Code	Original Nº	Modelos / Models	Posición / Position	Ø
 <p>M-12 x 1 con cono / with cone</p>	<b>K-6351</b>	11522 002 420 59 18	Unimog 416	Delantero Front Dianteiro	1" 3/8
 <p>M-12 x 1 con cono / with cone</p>	<b>K-6350</b>	003 420 00 18	Unimog 416	Trasero Rear Traseiro	13/16
 <p>M-12 x 1 con cono / with cone</p>	<b>K-6450</b>	24201818	L 1112 / 1113	Delantero Front Dianteiro	1" 5/8
 <p>M 12 x 1 - con cono / with cone</p>	<b>K-6452</b>	Varga RCCR 2322.8  Bendix 2403599	Argentina L 1114  Brasil L 321 / 1111 / 1113	Delantero Front Dianteiro	1" 5/8
 <p>M 12 x 1 - con cono / with cone</p>	<b>K-6453</b>		Argentina L 1114	Delantero Front Dianteiro	1" 5/8



**Cilindros de rueda**  
Wheel cylinders  
Cilindros de roda



**MERCEDES BENZ**

	Código/Code	Original Nº	Modelos / Models	Posición / Position	Ø
 <p>137 mm</p> <p>M 12 x 1 - con cono / with cone</p>	<b>K-6454</b>	Varga RCCR 2422.4  Bendix 2403600	Argentina L 1114  Brasil L 2013 / 2213	Trasero Rear Traseiro	1" 3/4
 <p>147 mm</p> <p>M 12 x 1 - con cono / with cone</p>	<b>K-6455</b>		Argentina L 1114	Trasero Rear Traseiro	1" 3/4
 <p>M 12 x 1 - con cono / with cone</p>	<b>K-6550</b>	Varga RCCR 2423.2	Argentina L 1517 / L 1518  Brasil L 1313 / 1316 / 1419 OF 1313 OH 1316 / 1517	Delantero Front Dianteiro	1" 27/32
 <p>M 12 x 1 - con cono / with cone</p>	<b>K-6551</b>	Varga RCCR 2424.0	Argentina L 1517 / L 1518  Brasil L 1313 / 1316	Trasero Rear Traseiro	2"
 <p>M-12 x 1 con cono / with cone</p>	<b>K-6250</b>	Varga RCCR 0002.3  3331413	L 608 72/86  L / LO 608 72/86	Delantero - Trasero Front - Rear Dianteiro - Traseiro	7/8

**Cilindros de rueda**  
Wheel cylinders  
Cilindros de roda



**MERCEDES BENZ**

	Código/Code	Original Nº	Modelos / Models	Posición / Position	Ø
 <p>M-12 x 1 con cono / with cone</p>	<b>K-6251</b>	51080	L 608 85->	Delantero Front Dianteiro	1" 1/16
 <p>M-10 x 1</p>	<b>K-6253</b>	Varga RCCR 0017.1  3331416  M. Benz 688 420 03 18	Argentina L 709 / L 710 LO 814  Brasil L 709 / 912 LO 812	Trasero Rear Traseiro	1" 1/8

**REO**

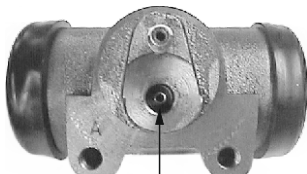
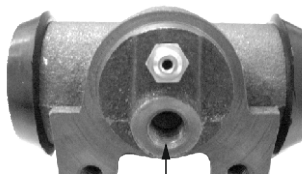
	Código/Code	Original Nº	Modelos / Models	Posición / Position	Ø
 <p>M-12 x 1 con cono / with cone</p>	<b>K-9950</b>		Camión / Truck	Delantero Front Dianteiro	1" 3/8
 <p>M-12 x 1</p>	<b>K-9951</b>		Camión / Truck	Trasero Rear Traseiro	1" 1/2

**TATA**

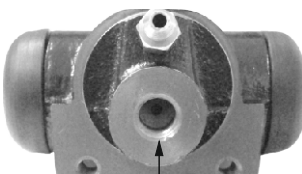
	Código/Code	Original Nº	Modelos / Models	Posición / Position	Ø
 <p>M-10 x 1</p>	<b>K-9650</b>	N 264042120102	608/609	Delantero - Trasero Front - Rear Dianteiro - Traseiro	15/16